



Test Certificate

Part Automated Disintegration Basket
(for 6 Tubes)

Part Number 23130-01

Serial Number 7164 - 7184

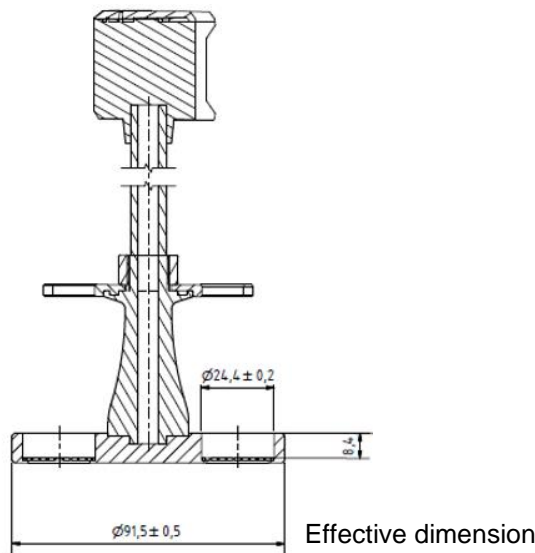

	USP / Ph.Eur	Tolerances
Dimensions	Bottom plate \varnothing	90.0 mm ± 2.0 mm
	Distance to sieve	6.75 mm ± 1.75 mm
	6 Holes \varnothing	24 mm ± 2.00 mm
Material	PMMA, POM, PVC, PA	

USP / Ph.Eur conformity (acc. USP701 / Ph Eur 2.9.1) :

The design of the basket-rack assembly may be varied somewhat, provided the specifications for the glass tubes and the screen mesh size are maintained.

(separate Certificates for Glass tube #12514 and Sieve plate # 23440-01)

The accuracy of the above mentioned part dimensions have been examined. All relevant measurements are within tolerance and the factory acceptance test has passed.

Aesch, 2021-02-08

Bruno Balli
SOTAX Quality Management
SOTAX AG | Nordring 1 | 4147 Aesch | Switzerland