

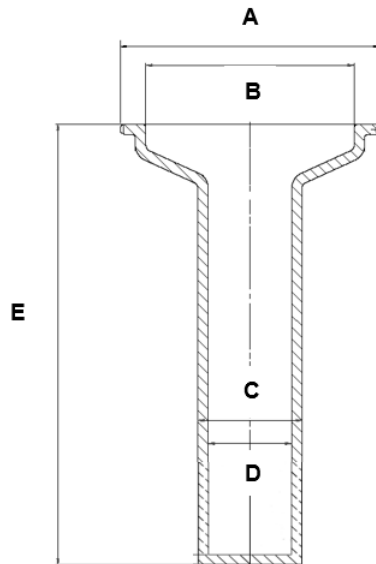

# Test Certificate

Part Vessel Mini Stirrer  
Part Number 10649  
Serial Number 84449 - 84455



		Tolerances		
<b>Dimensions</b>	Vessel	Outside Ø A	124.5 mm	+ 0.3 / - 0.2 mm
		Inside Ø B	100.0 mm	± 0.5 mm
		Outside Ø C	50.0 mm	± 1.0 mm
		Inside Ø D	40.0 mm	± 1.0 mm
		Height E	204.5 mm	± 0.5 mm
<b>Material</b>	Borosilicate glass			

The accuracy of the above mentioned part dimensions have been examined. All relevant measurements are within tolerance and the factory acceptance test has passed.

Aesch, 2020-11-25

Bruno Balli  
SOTAX Quality Management  
SOTAX AG | Nordring 1 | 4147 Aesch | Switzerland