

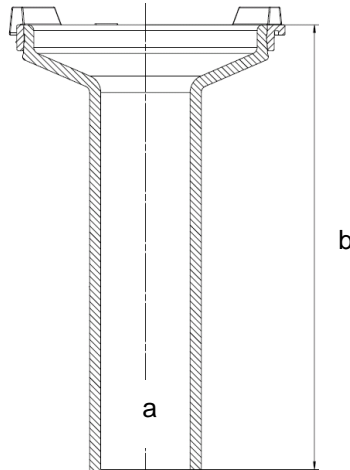

Test Certificate

Part Vessel for Enhancer Cell
Part Number 14534-01
Serial Number 88947 - 88967



		Tolerances		
Dimensions	Vessel	Inside Ø a	40.0 mm	± 1.0 mm
		Height b	199.0 mm	± 0.5 mm
Material	Borosilicate glass			

The accuracy of the above mentioned part dimensions have been examined. All relevant measurements are within tolerance and the factory acceptance test has passed.

Aesch, 2022-04-08

Bruno Balli
SOTAX Quality Management
SOTAX AG | Nordring 1 | 4147 Aesch | Switzerland